

MacroMagnum

- ... allows mounting of both MacroMagnum and Macro pallets
- ... reduces setting-up times
- ... ensures precision and quality
- ... can handle high machining forces
- ... is suitable for automatic changing with System 3R's automation program.

MacroMagnum is larger variant of the patented Macro system. The high clamping force and the position of the reference surfaces far away from the chuck centre mean that MacroMagnum can provide "Macro class" stability and accuracy, even in applications with high machining forces. The double references of the chucks mean that in addition to the MacroMagnum pallets, the extensive range of Macro pallets can also be fixed to MacroMagnum.

The difference between a pallet and a reference element

Usually the electrode blank is mounted directly on the pallet, which then carries the blank throughout the manufacturing process – from machine to machine, without subsequent alignment.

The reference elements are primarily intended to be mounted on the fixtures or vices in which the workpiece will be clamped. The reference elements are significantly thinner in order to limit the total construction height.

- + Repetition accuracy – within 0.002 mm
- + Locking force – 16 000 N
- + Fixed index positions – 4x90°
- + Required air pressure, pneumatic chuck – 6±1 bar
- + Recommended tightening torque manual chuck – Macro-pallet 4 Nm
- + Recommended tightening torque manual chuck – MacroMagnum-pallet 10 Nm.

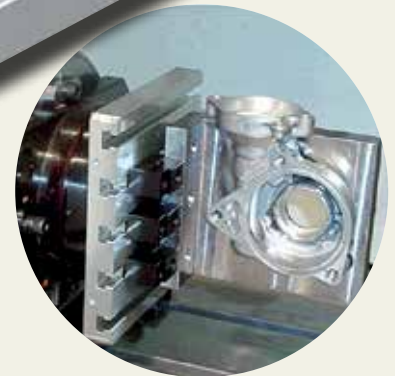
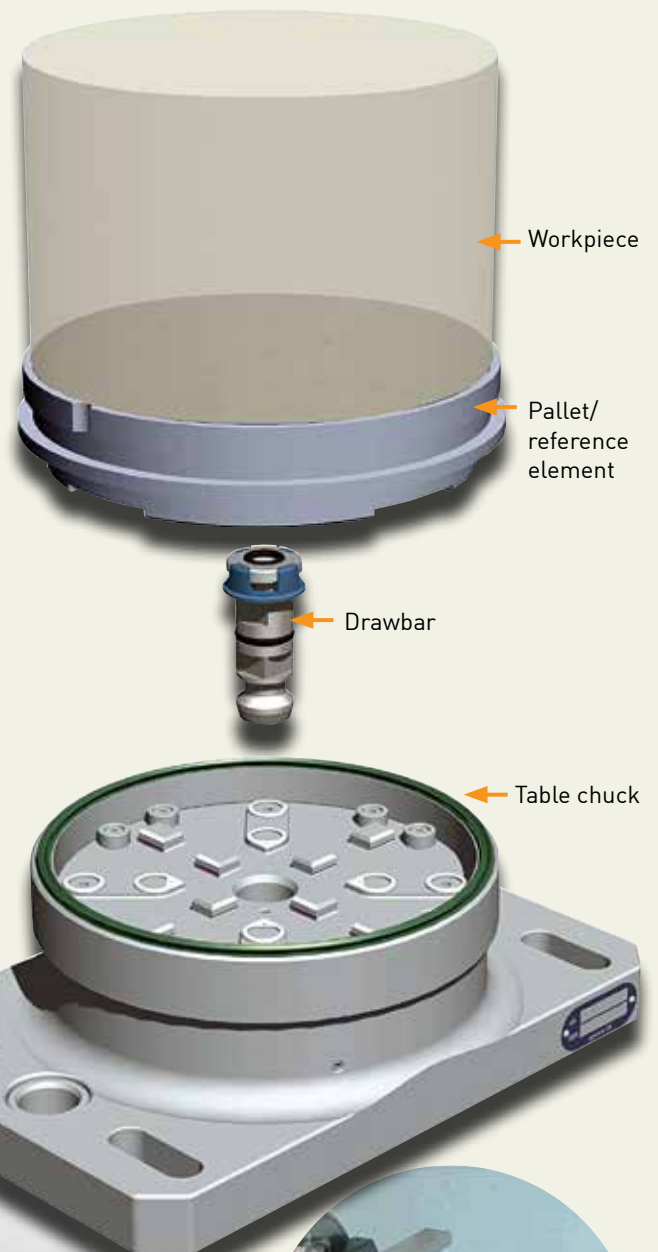

MacroMagnum – Chucks

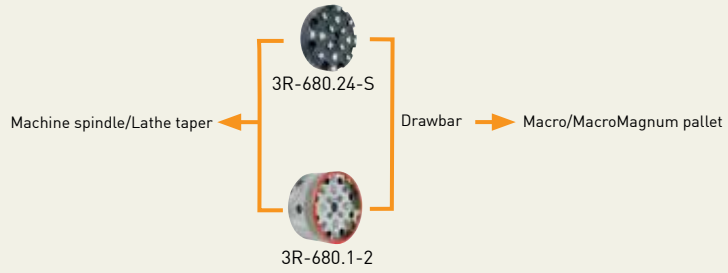
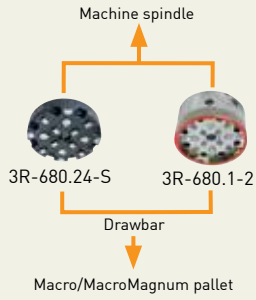

Spindle chucks	Article number	Drawbar	Feature
Manual	3R-680.24-S	3R-605.2	low profile
Pneumatic	3R-680.1-2	3R-605.1 / 3R-605.4	

Lathe chucks	Article number	Drawbar	Feature
Manual	3R-680.24-S	3R-605.2	low profile, fits 90809.01-10
Pneumatic	3R-680.1-2	3R-605.1 / 3R-605.4	

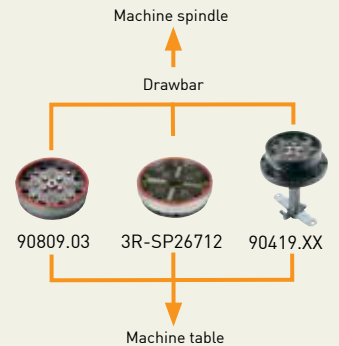
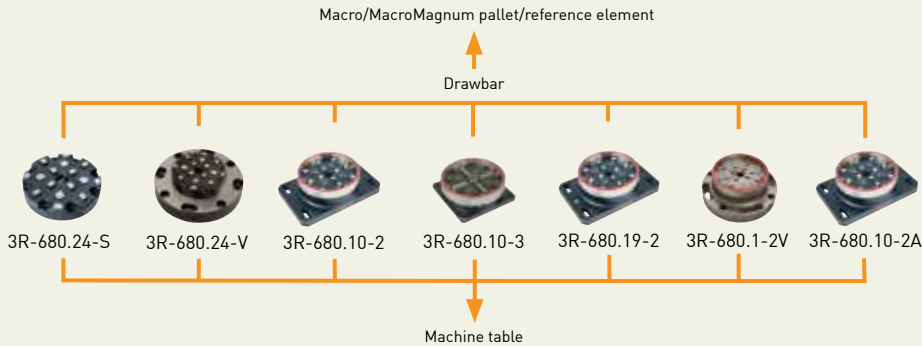

Table chucks	Article number	Drawbar	Feature
Manual	3R-680.24-S	3R-605.2	low profile
Manual	3R-680.24-V	3R-605.2	vibration-damped
Pneumatic	3R-680.10-2	3R-605.1 / 3R-605.4	
Pneumatic	3R-680.10-3	3R-605.2	low profile
Pneumatic	3R-680.19-2	3R-605.1 / 3R-605.4	3Refix Ø20 mm
Pneumatic	3R-680.1-2V	3R-605.1 / 3R-605.4	vibration-damped
Pneumatic	3R-680.10-2A	3R-605.1 / 3R-605.4	for chuck adapter

Built-in chucks	Article number	Drawbar	Feature
Pneumatic	90809.03	3R-605.1 / 3R-605.4	
Pneumatic	3R-SP26712	3R-605.2	low profile
Pneumatic	90419.XX	3R-605.1 / 3R-605.4	



MacroMagnum – Chucks

Manual chuck, 3R-680.24-S

Low profile chuck for permanent mounting on the machine spindle or table.

Note: Master pallet 3R-606.1 or 3R-686.1-HD is required at installation.

- Required drawbar 3R-605.2
- Recommended tightening torque: Macro pallet 4 Nm
MacroMagnum pallet 10 Nm
- Fixed index positions 4x90°
- Weight 5 kg.

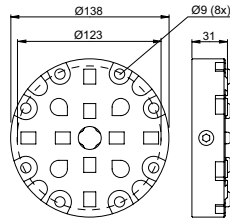

Manual chuck, VDP, 3R-680.24-V

Manual vibration-damped table chuck.

- Required drawbar 3R-605.2
- Recommended tightening torque: Macro pallet 4 Nm
MacroMagnum pallet 10 Nm
- Fixed index positions 4x90°
- Weight 10 kg.

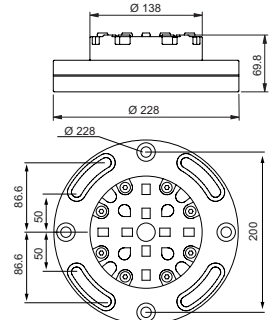

Pneumatic chuck, 3R-680.1-2

Pneumatic chuck for machine spindles and lathes.

Opened/locked by an air gun against a valve on the side, or alternatively on the back, of the chuck.

- Required drawbar 3R-605.1 or 3R-605.4
- Required air pressure 6 ±1 bar.
- Fixed index positions 4x90°
- Sealing ring
- Turbo-locking of MacroMagnum pallets
- Weight 9 kg.

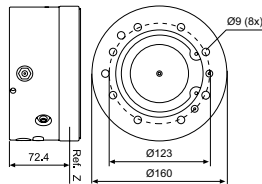

Pneumatic chuck, 3R-680.10-2

Pneumatic table chuck.

- Required drawbar 3R-605.1 or 3R-605.4
- Required air pressure 6 ±1 bar
- Fixed index positions 4x90°
- Air-blast cleaning of the Z-references
- Sealing ring
- Turbo-locking of MacroMagnum pallets
- Weight 12 kg.

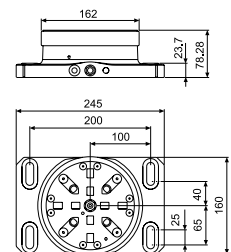

Pneumatic chuck, 3R-680.10-2A

Pneumatic table chuck for chuck adapter.

- Required drawbar 3R-605.1 or 3R-605.4
- Required air pressure 6 ±1 bar
- Fixed index positions 4x90°
- Air-blast cleaning of Z-references on chuck and chuck adapter
- Sealing ring
- Turbo locking
- Weight 12 kg.

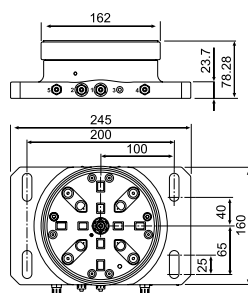

Pneumatic chuck, 3R-680.19-2

Pneumatic table chuck with 3Refix-holes.

- 3Refix Ø20 mm
- Required drawbar 3R-605.1 or 3R-605.4
- Required air pressure 6 ±1 bar
- Fixed index positions 4x90°
- Air-blast cleaning of the Z-references
- Sealing ring
- Turbo-locking of MacroMagnum pallets
- Weight 12 kg.

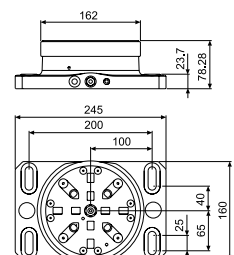

MacroMagnum – Chucks

Pneumatic chuck, VDP, 3R-680.1-2V

Pneumatic vibration-damped table chuck.

- Required drawbar 3R-605.1 or 3R-605.4
- Required air pressure 6 ± 1 bar
- Fixed index positions $4 \times 90^\circ$
- Air-blast cleaning of the Z-references
- Turbo locking
- Weight 13 kg.

VDP[®]

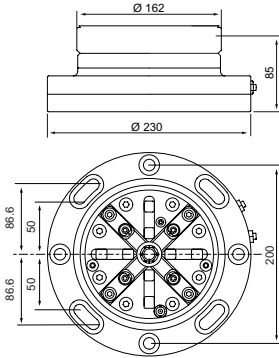

Pneumatic chuck, 3R-SP26712

For permanent mounting on the machine table.

- Supplied with drawbar 3R-605.2
- Required air pressure 6 ± 1 bar
- Fixed index positions $4 \times 90^\circ$
- Flushing duct
- Air-blast cleaning of the Z-references
- Sealing ring
- Turbo locking
- Weight 5 kg.

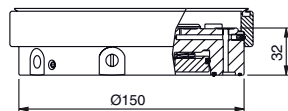
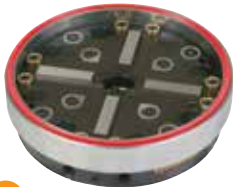

Pneumatic chuck, 90809.03

Pneumatic chuck intended for permanent building-in.

- Required drawbar 3R-605.1 or 3R-605.4
- Required air pressure 6 ± 1 bar
- Fixed index positions $4 \times 90^\circ$
- Flushing duct
- Air-blast cleaning of the Z-references
- Sealing ring
- Turbo locking
- Weight 5 kg.

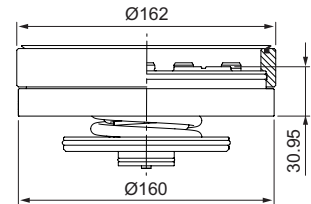

Pneumatic chuck, 3R-680.10-3

For permanent mounting on the machine table.

- Supplied with drawbar 3R-605.2
- Required air pressure 6 ± 1 bar
- Fixed index positions $4 \times 90^\circ$
- Flushing duct
- Air-blast cleaning of the Z-references
- Sealing ring
- Turbo locking
- Weight 7.5 kg.

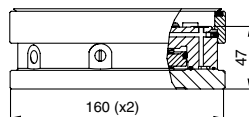

MacroMagnum – Chuck adapters

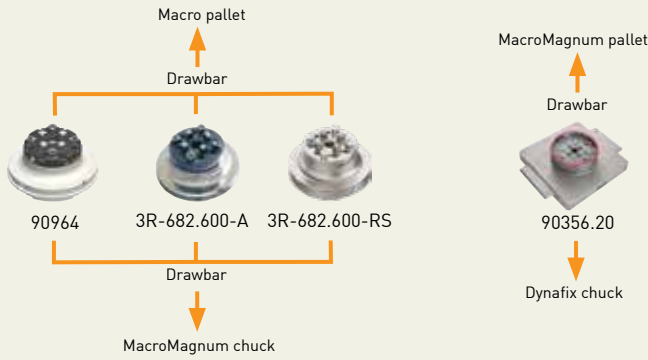

Chuck adapters	Article number	Drawbar	Feature
Pneumatic	90964	3R-605.1 / 3R-605.4 + 3R-605.2	MacroMagnum ► Macro
Pneumatic	3R-682.600-A	3R-605.1 / 3R-605.4 + 3R-605.2	MacroMagnum ► Macro
Pneumatic	3R-682.600-RS	3R-605.1RS	MacroMagnum ► Macro
Pneumatic	90356.20	3R-605.2 / 3R-605.4	Dynafix ► MacroMagnum

Pneumatic chuck adapter, MacroMagnum-Macro, 3R-682.600-A

Chuck adapter with built-in pneumatic Macro chuck for mounting in 3R-680.10-2A.

- Requires drawbar 3R-605.1RS
- Carbide X & Y-References
- Clamping force 6000 N
- Turbo locking
- Max load 50 kg to acquire accuracy 0.002 mm
- Weight 4.5 kg

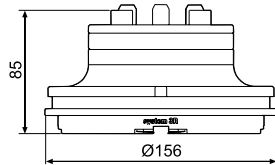

Pneumatic chuck adapter, MacroMagnum-Macro, 3R-682.600-RS

Chuck adapter with built-in Pneumatic Macro chuck.

- Requires drawbar 3R-605.1RS
- Carbide X & Y-References
- Rust resistant
- Clamping force 6000 N
- Turbo locking
- Max load 50 kg to acquire accuracy 0.002 mm
- Weight 4.8 kg

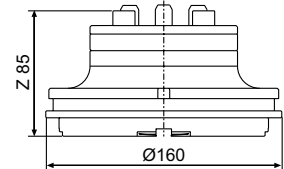

Manual chuck adapter, MacroMagnum-Macro, 90964

From MacroMagnum into Macro system. Chuck adapter with built-in Macro chuck.

- Requires drawbar 3R-605.2 or similar.
- Solid X & Y-References
- Recommended clamping torque 6 Nm
- Permissible torque 135 Nm
- Clamping force 6000 N
- Max load 50 kg to acquire accuracy 0.002 mm
- Weight 4.3 kg.

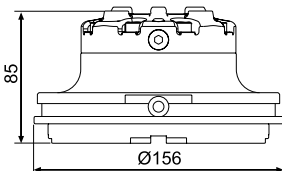

Pneumatic chuck adapter, Dynafix-MacroMagnum, 90356.20

Chuck adapter with built-in pneumatic MacroMagnum chuck for mounting in 90356.10 or similar. See Dynafix for further information.

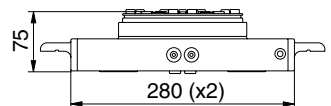

MacroMagnum – Pallets & reference element

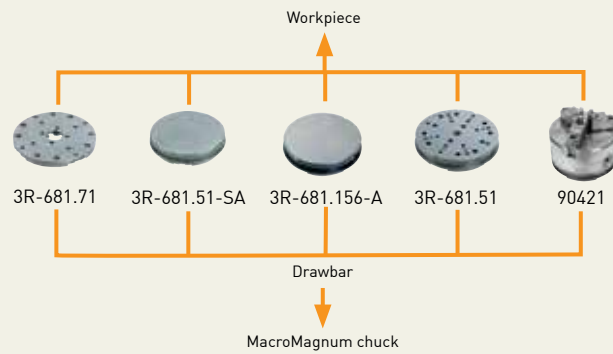

NOTE: All Macro pallets can be used in the MacroMagnum chucks.

Reference element Ø142 mm	Article number	Feature
Hardened reference element 12.5 mm	3R-681.71	rust-resistant
Pallets Ø156 mm	Article number	Feature
Unhardened pallet 35 mm	3R-681.51-SA	
Unhardened pallet 35 mm	3R-681.156-A	reference element Ø142 mm
Hardened pallet 35 mm	3R-681.51	3Refix Ø10 mm
Three-jaw chuck	90421	



Reference element Ø142 mm, 3R-681.71

Hardened pallet with clearance holes for fixing screws.

Note: Must be mounted on the workpiece/fixture before it is locked in a chuck.

- Rust-resistant
- Weight 1 kg.

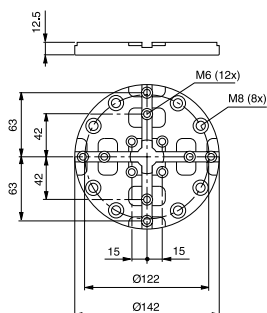

Pallet Ø156 mm, 3R-681.51-SA

Unhardened pallet with hardened references and hole markings for eight clearance holes.

- Adapted for automatic changing
- Ready for code carrier
- Weight 4.5 kg.

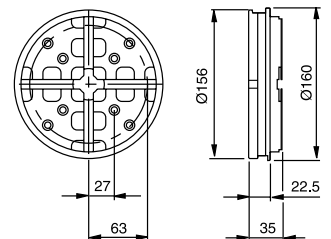

MacroMagnum – Pallets & accessories

Pallet Ø156 mm, 3R-681.156-A

Unhardened pallet with hardened reference element type 3R-681.71.

- Adapted for automatic changing
- Ready for code carrier
- Weight 4.5 kg.

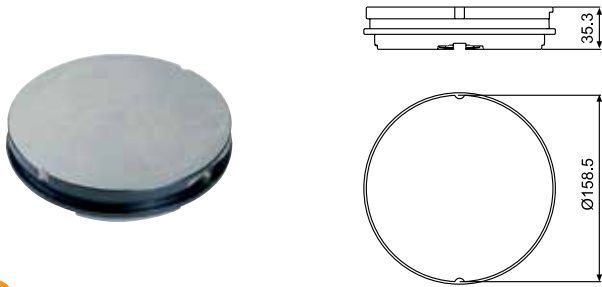

Pallet Ø156 mm, 3R-681.51

Hardened pallet with threads and clearance holes for eight and ten fixing screws.

- 3Refix Ø10 mm
- Adapted for automatic changing
- Ready for code carrier
- Rust-resistant
- Flushing connection
- Weight 5 kg.

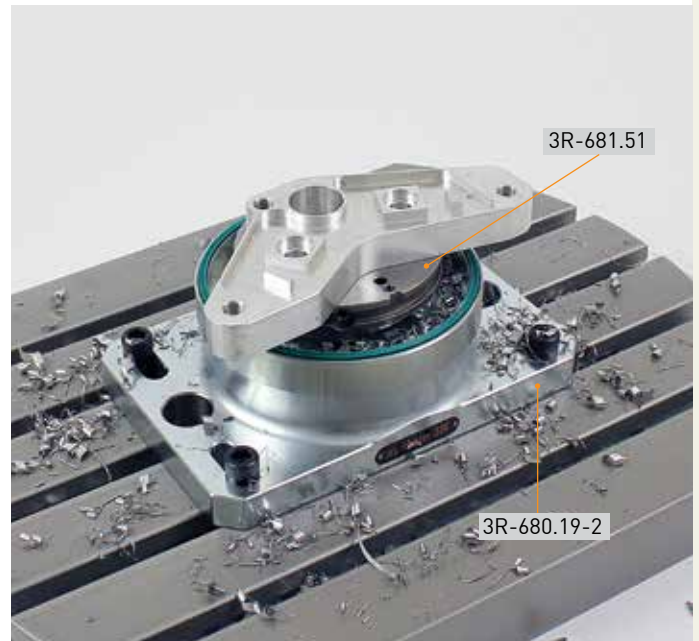
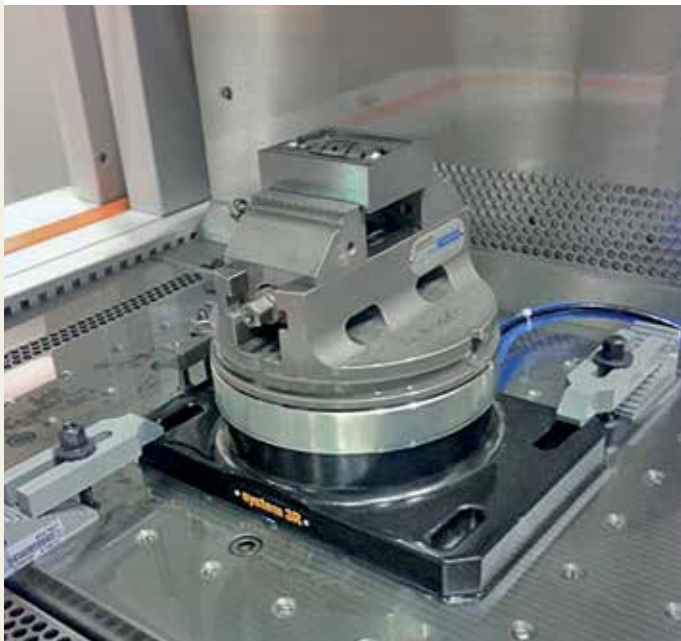
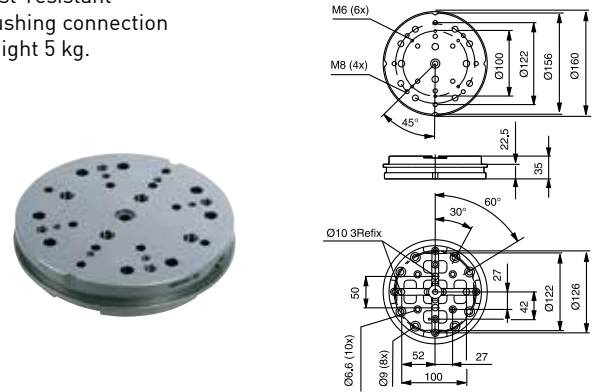

Drawbars

3R-605.1E

- Ø20x57.1 mm with flushing holes Ø7 mm
- Supplied in sets of 10 pcs.

3R-605.1EE

- Supplied in sets of 40 pcs.



3R-605.4E

For round pallets adapted for automatic changing.

- Ø20x57.1 without flushing hole
- Supplied in sets of 10 pcs.

3R-605.4EE

- Supplied in sets of 40 pcs.



3R-605.2E

- Ø20x36.9 mm with Ø7 mm flushing hole
- Supplied in sets of 5 pcs.



3R-605.2EE

- Supplied in sets of 20 pcs.

MacroMagnum – User kit & Accessories



Three-jaw chuck, 90421

Three-jaw chuck mounted on pallet 3R-681.51-SA.

- Adapted for automatic changing
- Ready for code carrier
- Total height 127 mm
- Weight 16 kg.



User kit, 3R-688.24-S

3R-680.24-S MacroMagnum chuck, Manual, Low profile, 1 pc.

3R-681.51-SA MacroMagnum Pallet Ø156 mm, 4 pcs.

3R-605.2 Drawbar, 2 pcs.



Check ruler, 3R-686.1-HD

Check ruler for setting flatness and angular positions. Ground hole for centring.

- Adapted for automatic changing
- Ready for code carrier
- Measuring length 130 mm
- Weight 6 kg.



Splash guard, 90027.03

Intended for MacroMagnum chucks. Can also be used as a cover for unused chucks.



3Refix mandrel, 3R-901-10E-TX

- 3Refix Ø10 mm
- Recommended tightening torque 4 Nm
- Supplied in sets of 10 pcs.
- Weight per set 0.2 kg.

Note: When positioning with 3Refix mandrels – always tighten the expanding mandrel in the R⁰ hole first.



MacroMagnum – Accessories

Control unit, 3R-611.2

Foot operation of pneumatic chucks.



Control unit, 3R-611.4

Unit for operation of pneumatic chucks.
Two functions, opened/closed.



Control unit, 3R-611.46

Unit for hand operation of pneumatic chucks. Three functions – open/neutral/closed.

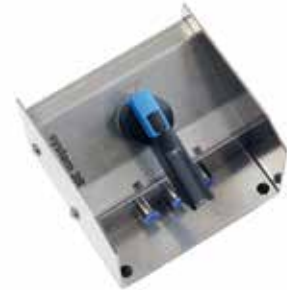

Torque wrench, 3R-614-04

For Ø10 mm 3Refix mandrels and manual MacroMagnum chucks.

- 4 Nm.



Code carriers, 3R-863.01-10

With pre-programmed unique identity, designed for pallet use.

- Supplied in sets of 10 pcs.



Connection for air gun, 90815

For manual operation of pneumatic chucks with air gun.

- Supplied in sets of 2 pcs.



Clamping force meter kit, 3R-SSP115-BASE

For both pneumatic and manual chucks. This stand alone unit in combination with individual drawbars or drawbar kits, able to cover MacroJunior, Macro, MacroMagnum and Dynafix.

Note: Require drawbars with bayonet interface similar to 3R-605.1.

- Add-on kit for use in Macro/MacroMagnum, 3R-SSP115-Macro
- Operating temp. +10 to +40° C
- Gauge size Ø90x47 mm
- Working range 1-22 kN
- Deviation ± 0.1 kN.
- Weight:
Display 0.34 kg.
Gauge 1.3 kg.



Add-on kit, 3R-SSP115-Macro

Add-on kit for 3R-SSP115-BASE

