

GPS 70 & GPS 120

- ... reduces setting-up times.
- ... ensures precision and quality.
- ... is sealed against dirt and swarf.
- ... has pallet clamping without drawbar.
- ... has lightweight pallets.
- ... suitable for automatic changing with System 3R's automation program.

The machining zero point is defined by the centre of the chuck in the GPS 70 and GPS 120 system. The chucks can be mounted on the machine table of any machine tool.

The standardised hole pattern of the pallet allows the fixation of workpieces, fixtures and accessories such as vices and three-jaw chucks from below. This gives collision-free mounting, even with five-sided machining.

The economical, pressure-die-cast aluminium pallets are very light, making them also suitable for manual handling. Naturally GPS 70 and GPS 120 are also suitable for automatic changing.

The chuck seal prevents dirt penetrating between the chuck and the pallet. This simplifies maintenance and lengthens the life of the components.

- + Repetition accuracy – within 0.002 mm
- + Indexing accuracy – within 0.005 mm
- + Locking force – 3 000-3 800 N
- + Fixed index positions – 4x90°
- + Required air pressure, pneumatic chuck – 6 bar
- + Recommended max workpiece weight GPS 70 – 10 kg
- + Recommended max workpiece weight GPS 120 – 20 kg



GPS 70 & GPS 120

Die-cast aluminium & steel pallets with standardised hole pattern. Minimum height in automation magazines by clamping without drawbar.



Pallet handling contour for automated pallet change by robot.



The Z-references are air blast cleaned, through nozzles in the Z-references of the chuck.

Spring loaded clamping mechanism. Releasing by air.



GPS 120 ring with references.

GPS 70 ring with references.







Hardened chuck body with prisms for X/Y centring made out of one piece for maximum stability. Indexing 4x90°.

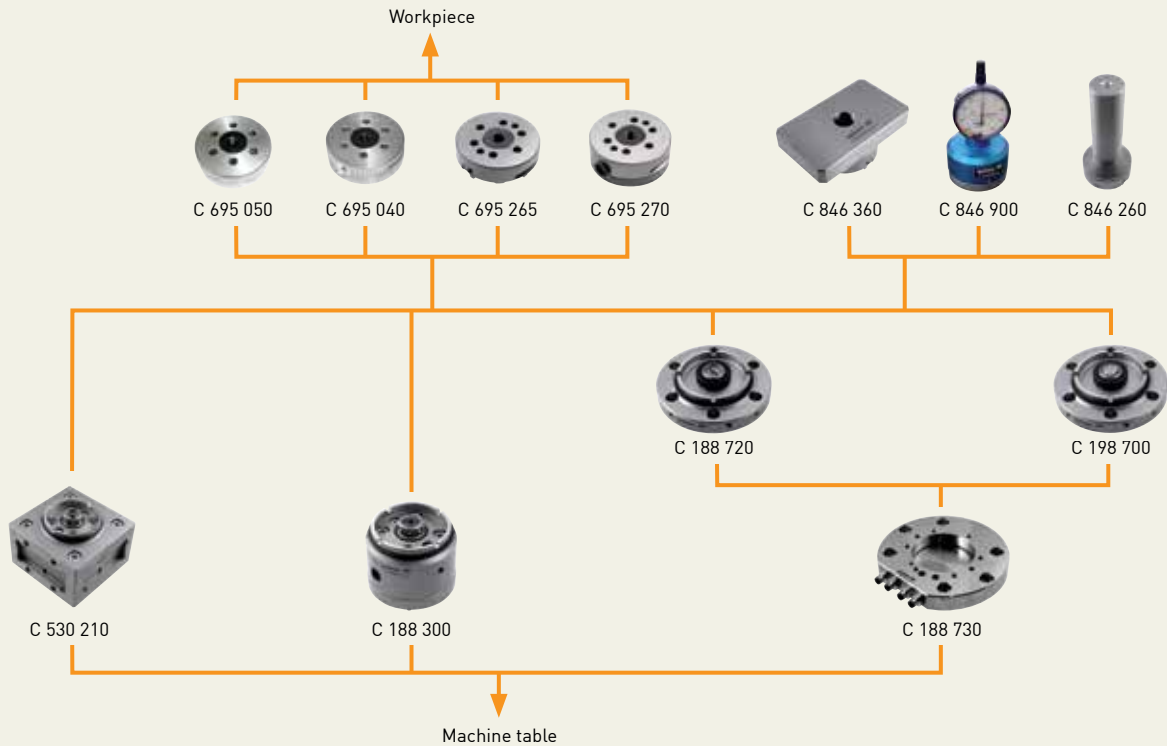

Sealing rings for completely sealed chuck-pallet interface against dirt and swarf.

GPS 70 – Chucks & pallets



Chucks	Article number	Feature
Manual, cube	C 530 210	
Manual, round	C 188 300	
Pneumatic manual (automatic)	C 188 720	for manual machining operations
Pneumatic automatic/manual	C 198 700	for manual & automatic machining operations
Flange	C 188 730	fits on C 188 720 & C 188 700

Pallets	Article number	Feature
Cast aluminium 	C 695 050	
Cast aluminium 	C 695 040	
Steel 	C 695 265	
Steel 	C 695 270	with pallet protection ring
Pallet protecting ring	C 695 295	fits on C 695 265

 Pallet with coined cams  Pallet with springy hardened cams



GPS 70 – Chucks

GPS 70 Machining cube, manual, C 530 210

For milling, grinding, die-sinking EDM, presetting and measuring station. Suitable for the 5-sided machining of electrodes and workpieces. One side is ground square with the base surface.

- Dimensions 100 x 100 x 70 mm
- Mounting (from the top) 70 x 70 mm, 4x M8 screws through holes (horizontal)
- Mounting (from the bottom) on GPS 240 pallet: 80 x 80 mm, 4x M8 screws threaded holes (horizontal), 40 x 40 mm, 4x M8 screws threaded holes (vertical)
- Releasing manual with Allen wrench.

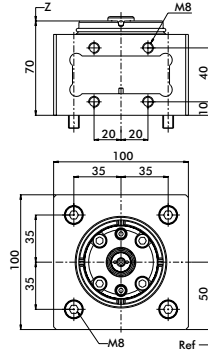

GPS 70 Chuck, manual, C 188 300

For turning, milling, grinding, die-sinking EDM.

- Dimensions $\varnothing 72.4 \times 57.4$ mm
- Mounting 4x M6 screws
- Releasing manual with Allen wrench
- Flushing lateral inlet.

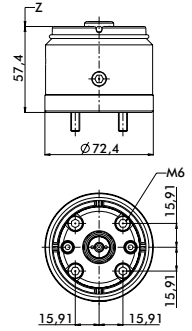

GPS 70 Chuck, pneumatic, C 188 720

For die-sinking EDM, turning, milling, grinding.

- Dimensions $\varnothing 99 \times 22$ mm
- Mounting 6x M6 screws (fits on flange C 188 730)
- Releasing pneumatic, 6 bar
- Required air pressure 6 bar
- Air-blast cleaning of Z-references.

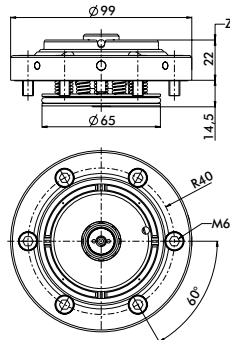

GPS 70 Chuck, pneumatic, C 198 700

For Automation.

- Dimensions $\varnothing 99 \times 22$ mm
- Mounting 6x M6 screws (fits on flange C 188 730)
- Releasing pneumatic, 6 bar
- Required air pressure 6 bar
- Air-blast cleaning of Z-references.

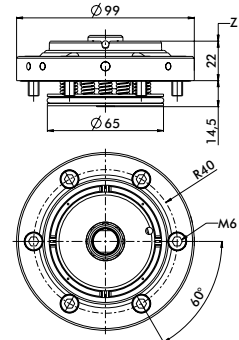

Flange for GPS 70 chuck, C 188 730

Fits on C 188 720 and C 198 700.

- Material: stainless steel, heat pre-treated
- Dimensions $\varnothing 140 \times 20$ mm
- Mounting 6x M8
- Connections:
 - A = releasing/clamping
 - B = Air-blast cleaning of Z-references
 - C = drain/pallet room venting
 - D = piston room venting.

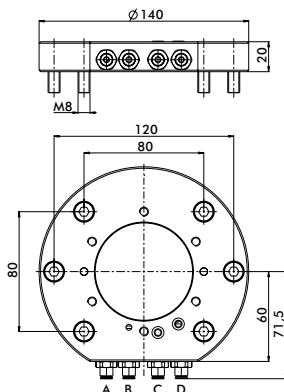

GPS 70 – Pallets

GPS 70 Aluminium pallet, C 695 050

Cast aluminium pallet.

- Construction height 16.7 ± 0.01 mm
- X/Y-centring with coined cam
- Weight 0.2 kg.
- Not prepared for automation.

Set of pallets, S 500 010

- C 695 050 supplied in sets of 9 pcs.

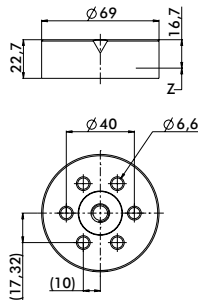

GPS 70 Aluminium pallet, C 695 040

Cast aluminium pallet.

- Construction height 16.7 ± 0.01 mm
- X/Y-centring with coined cam
- Ready for code carrier fixture C 960 740
- Weight 0.2 kg.
- Prepared for automation.

Set of pallets, S 500 011

- C 695 040 supplied in sets of 9 pcs.

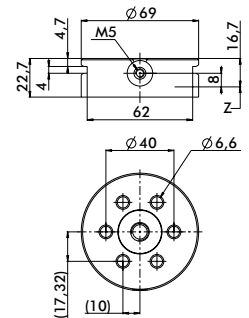

GPS 70 Steel pallet, C 695 265

Workpiece and device holder for precision production.

- Construction height 22 ± 0.005 mm
- X/Y-centring with springy cams, hardened, stainless
- Ready for code carrier fixture C 960 740
- Weight 0.5 kg.
- Prepared for automation.

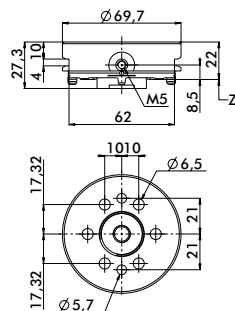

GPS 70 Steel pallet, C 695 270

Workpiece and device holder for precision production with pallet protection ring aluminium.

- Construction height 22 ± 0.005 mm
- X/Y-centring with springy cams, hardened, stainless
- Ready for code carrier 3R-863.01
- Weight 0.5 kg.
- Prepared for automation.

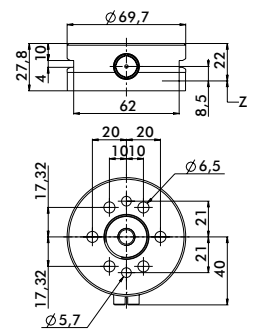

GPS 70 Pallet protection ring, C 695 295

Chip protection between pallet and chuck for GPS 70 steel pallets C 695 265.

- Material plastic
- Dimensions $\varnothing 69.4 \times 10.8$ mm
- Use with code carrier.

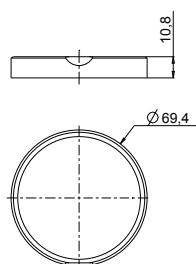

Pallet with coined cams Pallet with springy hardened cams



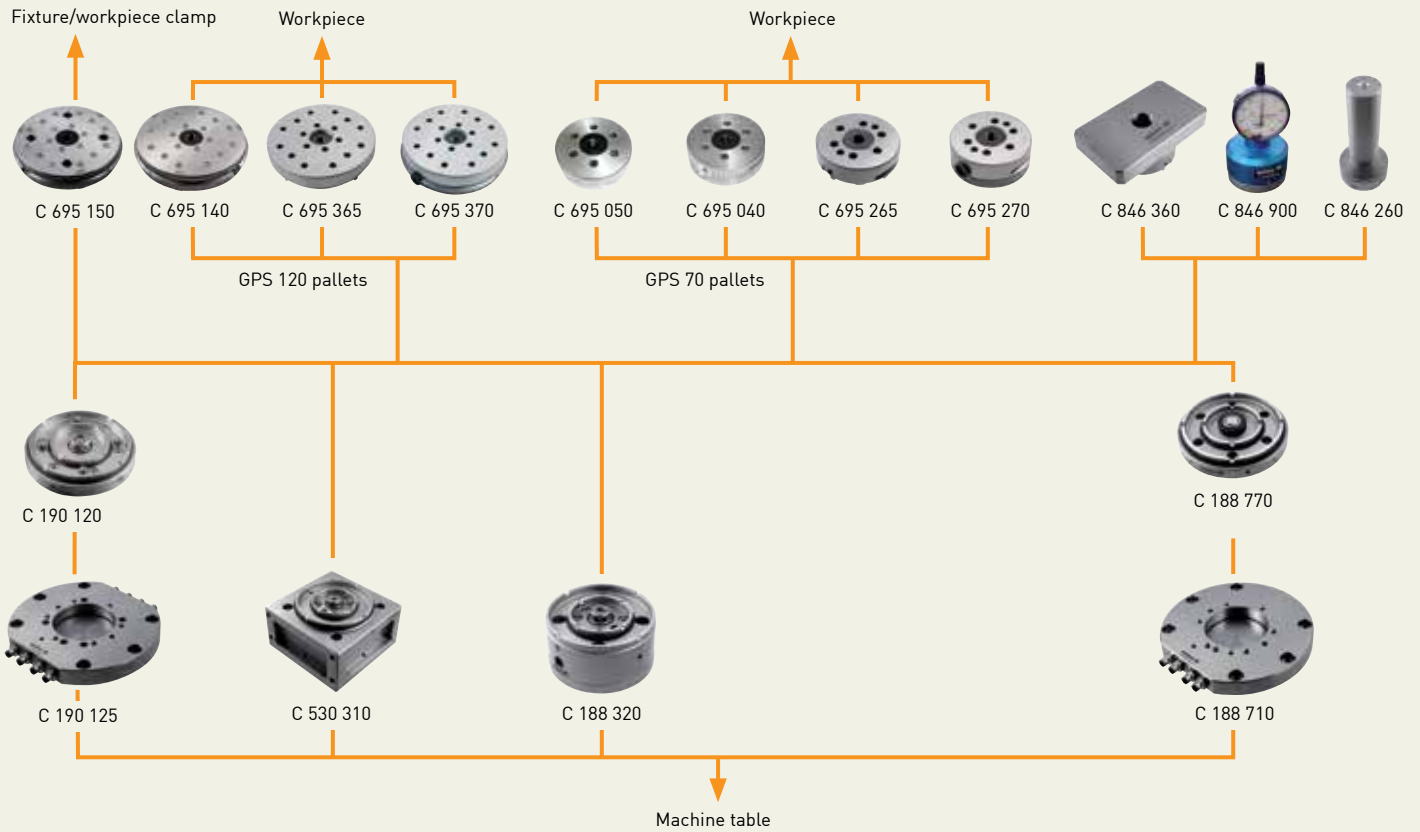

GPS 120 – Chucks & pallets





Chucks

	Article number	Feature
Manual, cube	C 530 310	
Manual, round	C 188 320	
Pneumatic automatic/manual	C 188 770	for manual & automatic machining operations
Pneumatic automatic/manual	C 190 120	with airdock 4-fold
Flange	C 188 710	fits on C 188 700 & C 188 770
Flange	C 190 125	fits on C 190 120

Pallets

	Article number	Feature
Cast aluminium	 C 695 140	
Cast aluminium	 C 695 150	with airdock 4-fold
Pneumatic manual (automatic)	 C 695 365	
Pneumatic automatic/manual	 C 695 370	with pallet protection ring
Pneumatic automatic/manual	C 695 395	fits on C 695 365

 Pallet with coined cams

 Pallet with springy hardened cams

GPS 120 – Chucks

GPS 120 Machining cube, manual, C 530 310

For milling, grinding, die-sinking EDM, presetting and measuring station. Suitable for the 5-sided machining of electrodes and workpieces. One side is ground square with the base surface.

- Dimensions 136 x 136 x 80 mm
- Mounting (from the top) 12 x 120 mm, 4x M8 screws threaded holes (horizontal)
- Mounting (from the bottom): on GPS 240 pallet 90 x 90 mm, 4x M8 screws through holes (horizontal), 120 x 40 mm, 4x M8 screws threaded holes (vertical)
- Releasing manual with Allen wrench.

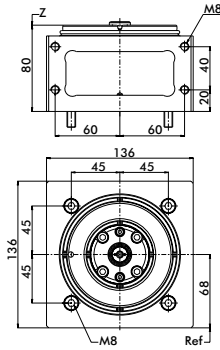

GPS 120 Chuck, manual, C 188 320

For turning, milling, grinding, die-sinking EDM.

- Dimensions $\varnothing 108.4 \times 57.4$ mm
- Mounting 4x M8 screws
- Releasing manual with Allen wrench
- Flushing lateral inlet.

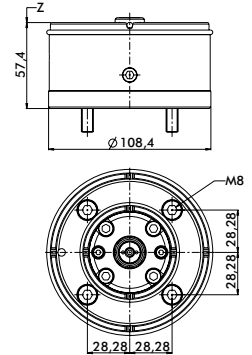

GPS 120 Chuck, pneumatic, C 188 770

For automation and manual use.

- Dimensions $\varnothing 118 \times 22$ mm
- Mounting 6x M6 screws (on flange C 188 710)
- Releasing pneumatic, 6 bar
- Required air pressure 6 bar
- Air-blast cleaning of Z-references only GPS 120.

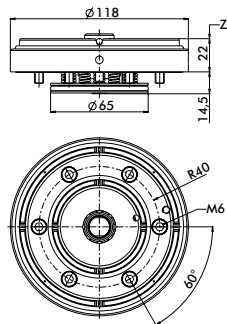

Flange for GPS 120 chuck, C 188 710

Fits on C 188 770.

- Material stainless steel, heat pre-treated
- Dimensions $\varnothing 160 \times 20$ mm
- Mounting 6x M8
- Connections:
 - A = releasing/clamping
 - B = Air-blast cleaning of Z-references
 - C = drain/pallet room venting
 - D = piston room venting

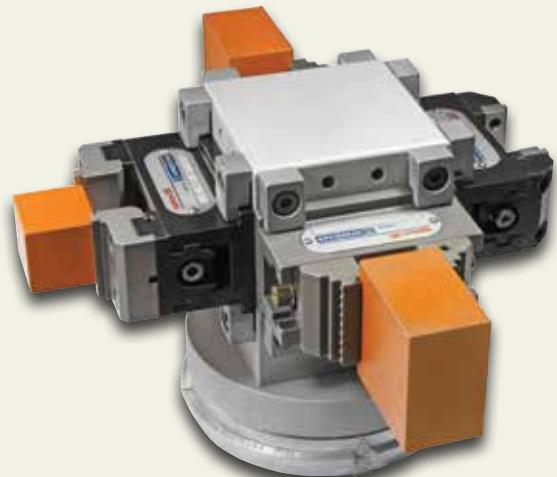
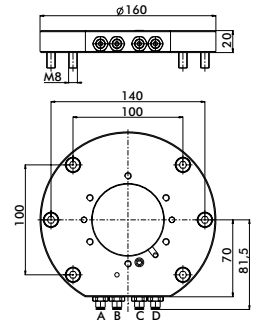

GPS 120 – Pallets

GPS 120 Aluminium pallet, C 695 140

Cast aluminium pallet.

- Construction height 16.6 ±0.01 mm
- X/Y-centring with coined cam
- Adapted for automatic changing
- Ready for code carrier fixture C 960 740
- Weight 0.5 kg.

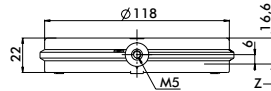

Set of pallets, S 500 021

- C 695 140 supplied in sets of 4 pcs.

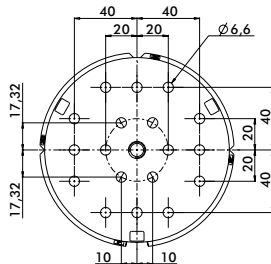

GPS 120 Steel pallet, C 695 365

Workpiece and device holder for precision production.

- Construction height 26 ±0.005 mm
- X/Y-centring with springy cams, hardened, stainless
- Not for automatic changing
- Weight 1.6 kg.

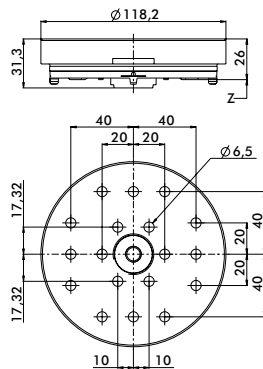

GPS 120 Steel pallet, C 695 370

Workpiece and device holder for precision production with pallet protection ring aluminium.

- Construction height 26 ±0.005 mm
- X/Y-centring with springy cams, hardened, stainless
- Adapted for automatic changing
- Ready for code carrier 3R-863.01
- Weight 1.7 kg.

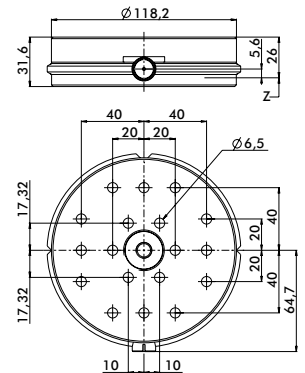

GPS 120 Pallet protection ring, C 695 395

Chip protection between pallet and chuck for GPS 120 steel pallets C 695 365.

- Material plastic
- Dimensions Ø118 x 15.7 mm
- Not to use with code carrier.

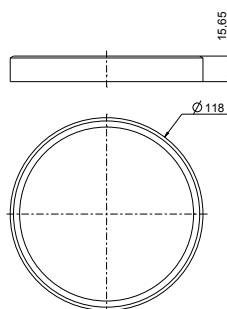

/// Pallet with coined cams

↘ Pallet with spring hardened cams

GPS 120 with airdock

The chuck with airdock is able to transfer the compressed air directly to the pallet via 4 interfaces.

Fixtures and clamping elements in the automation system, amongst other things, can be operated pneumatically with the pallet C 695 150.

The GPS 120 standard pallets can also be used on the system.



GPS 120 Chuck, pneumatic, C 190 120

With airdock 4-fold.

- Stainless steel, hardened
- Dimensions $\text{Ø}118 \times 22 \text{ mm}$
- Mounting 6x M6 screws (on flange C 190 125)
- Releasing pneumatic, 6 bar
- Required air pressure 6 bar
- Air-blast cleaning of Z-references GPS 120.
- Medium connection fourfold, pneumatic 6 bar.

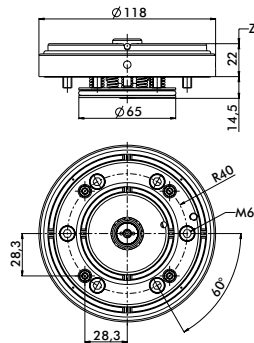

Flange for GPS 120 chuck, C 190 125

With airdock 4-fold. Fits on GPS 120 chuck C 190 120.

- Stainless steel, heat pre-treated
- Dimensions $\text{Ø}160 \times 20 \text{ mm}$
- Mounting 6x M8
- Connections:
 - A = releasing/clamping
 - B = Air-blast cleaning of Z-references
 - C = drain/pallet room venting
 - D = piston room venting
 - E-G = medium connection.

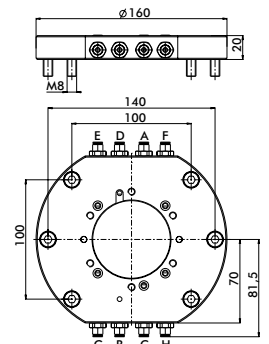

GPS 120 Aluminium pallet, C 695 150

With airdock 4-fold. Fits on GPS 120 chuck C 190 120.

- Airdock compressed air, max. 6 bar
- Construction height $16.6 \pm 0.01 \text{ mm}$
- X/Y-centring with coined cam
- Adapted for automatic changing
- Ready for code carrier fixture C 960 740

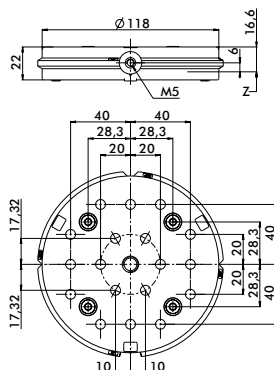

/// Pallet with coined cams

GPS 70 & 120 – Accessories

GPS 70 Reference pallet, C 846 360

For the axial and concentric XY alignment of the GPS 70/120 chuck.

- Material stainless steel, hardened
- Height 47 mm
- Construction: 2-piece, form-fitting design
- Repetition accuracy of the centre bore 0.002 mm/0°
- Parallelism with system axis 0.003 mm/120 mm.
- Adapted for automatic changing
- Ready for code carrier fixture C 960 740.

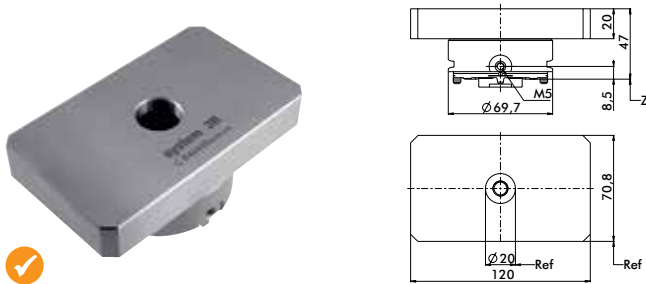

GPS 70 Inspection plug, C 846 260

For the radial alignment of the GPS 70/120 chuck.

- Material stainless steel, hardened
- Height 160 mm
- Construction 2-piece, form-fitting design
- Concentricity 0.005 mm/150 mm.
- Adapted for automatic changing
- Ready for code carrier fixture C 960 740.



GPS 70/120 Clamping force testing device, C 846 900

For measuring and adjusting the clamping force of manual chucks and for measuring the clamping force of pneumatic chucks.



GPS 70 Spare parts set, S 230 150

For GPS 70 pneumatic chucks C 188 720 and C 198 700.

- Contains all the elements for a complete service.

GPS 120 Spare parts set, S 230 100

For GPS 70/120 pneumatic chucks C 188 700 and C 188 770.

- Contains all the elements for a complete service.



GPS 70 Spare parts set, S 660 000

For GPS 70 manual chucks C 188 300 and C 530 210.

- Contains all the elements for a complete service.

GPS 120 Spare parts set, S 230 510

For GPS 120 manual chucks C 188 320 and C 530 310.

- Contains all the elements for a complete service.



GPS 70 & 120 – Accessories

GPS 70/120 Pallet seal, C 531 000

Sealing of unused bores.

- Material elastomer
- Delivery includes set of 100 pieces.

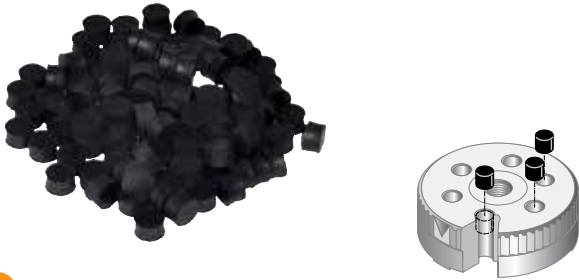

Control unit, C 960 500

Manual control unit for clamping and releasing pneumatic chucks.

- Connector materials included in delivery
- Connections clamping/releasing, cleaning of Z-supports.

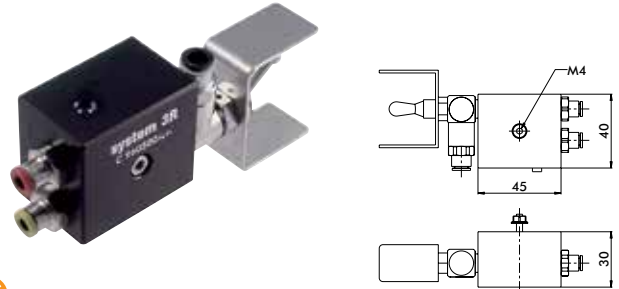

Code carriers, 3R-863.01

With pre-programmed unique identity, designed for GPS 70/120 pallets.

3R-863.01-10

- Sets of 10 pieces.



Code carrier, fixture, C 960 740

Fixture for code carrier 3R-863.01-10.

- The code carrier can be clicked into position.

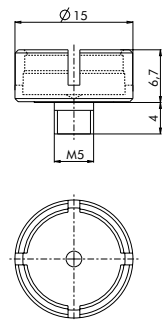

GPS 120 Chip protection, C 695 176

Chip protection ring for GPS 120 chucks when used manually with GPS 70 pallets C 695 050.

- Material aluminium, anodized
- Dimensions Ø120 x 13.5 mm.

