

AgieCharmilles

LASER P

600 U/1000 U

1200 U/4000 U

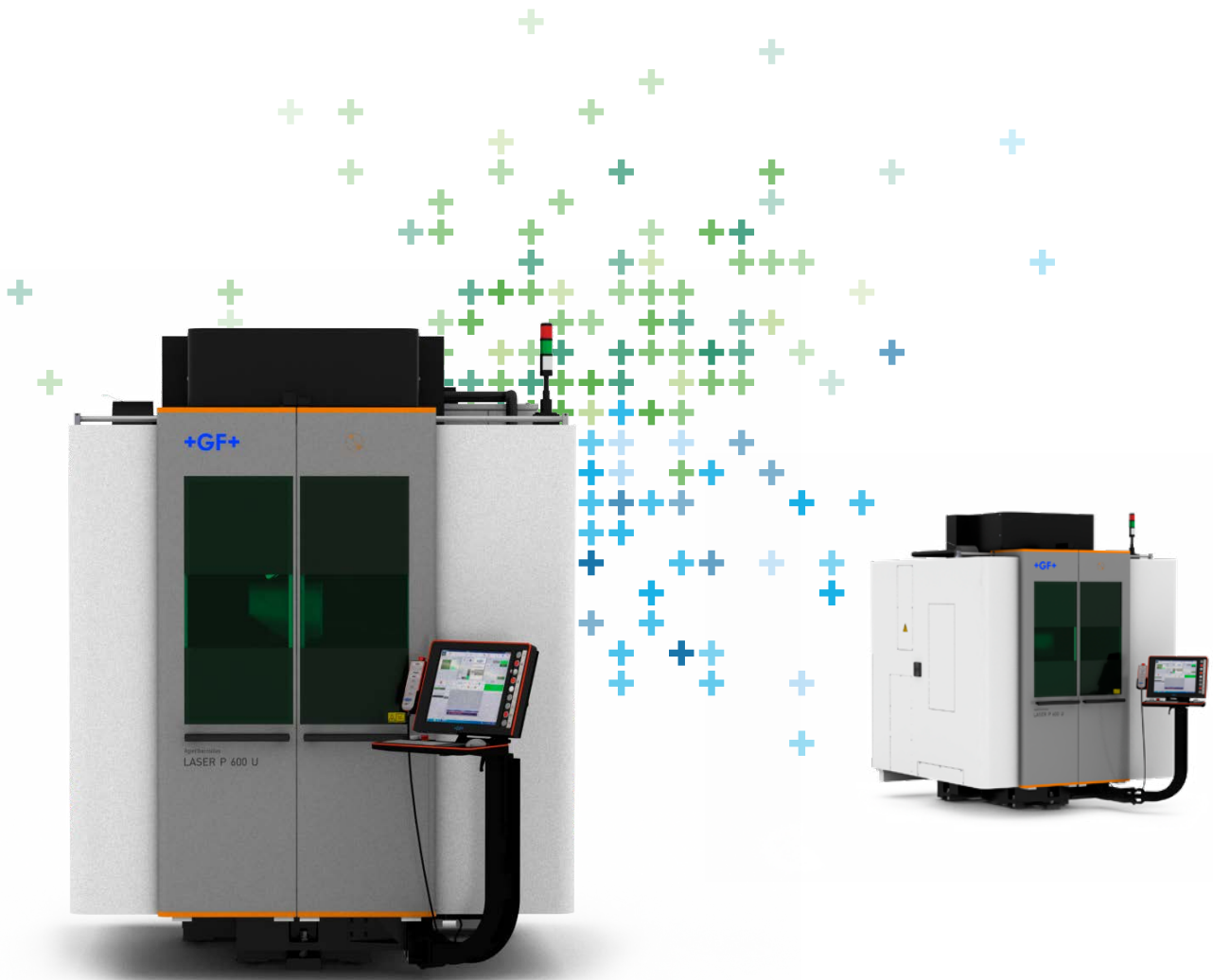

Becoming better every day – since 1802

GF Machining Solutions

When all you need is everything, it's good to know that there is one company that you can count on to deliver complete solutions and services. From unmatched Electrical Discharge Machining (EDM), Laser texturing, Laser micromachining, Additive Manufacturing and first-class Milling and Spindles to Tooling and Automation, all of our solutions are backed by unrivaled customer service and expert GF Machining Solutions training. Our AgieCharmilles, Microlution, Mikron Mill, Liechti, Step-Tec and System 3R technologies help you raise your game—and our digital business solutions for intelligent manufacturing, offering embedded expertise and optimized production processes across all industries, increase your competitive edge.



+ We are AgieCharmilles.
We are GF Machining Solutions.

Contents

4	We are
5	Laser texturing
6	Versatile texturing solution
7	Industry 4.0
8	Electronic consumers
9	Packaging
10	Automotive
12	Ease of use
14	Higher degree of autonomy
16	Act responsibly
17	Technical specifications
18	GF Machining Solutions

Experience our laser texturing solutions

GF Machining Solutions' full range of Laser texturing expertise helps you make your distinctive marks. Forward-thinking manufacturers recognize the benefits of GF Machining Solutions' Laser technology using high-powered ytterbium pulsed fiber lasers with a fine beam diameter down to 30 µm.

We are

The reference for mold and die solutions

Years of proven expertise

GF Machining Solutions has long been recognized as the market leader for mold and die solutions. Laser texturing was developed to provide efficient and outstanding texturing results. We provide new product design possibilities and superior technical support for the mold and die manufacturers around the world.

Laser texturing

Brings the future to you

GF Machining Solutions' high-precision Laser texturing solutions allows you to easily with infinite repeatability make your distinct mark on 3D geometries in a wide range of industries. These industries include automotive, consumer electronics, packaging, tooling, mold making, and lifestyle/consumer products (shoes, sporting products, and luxury goods).

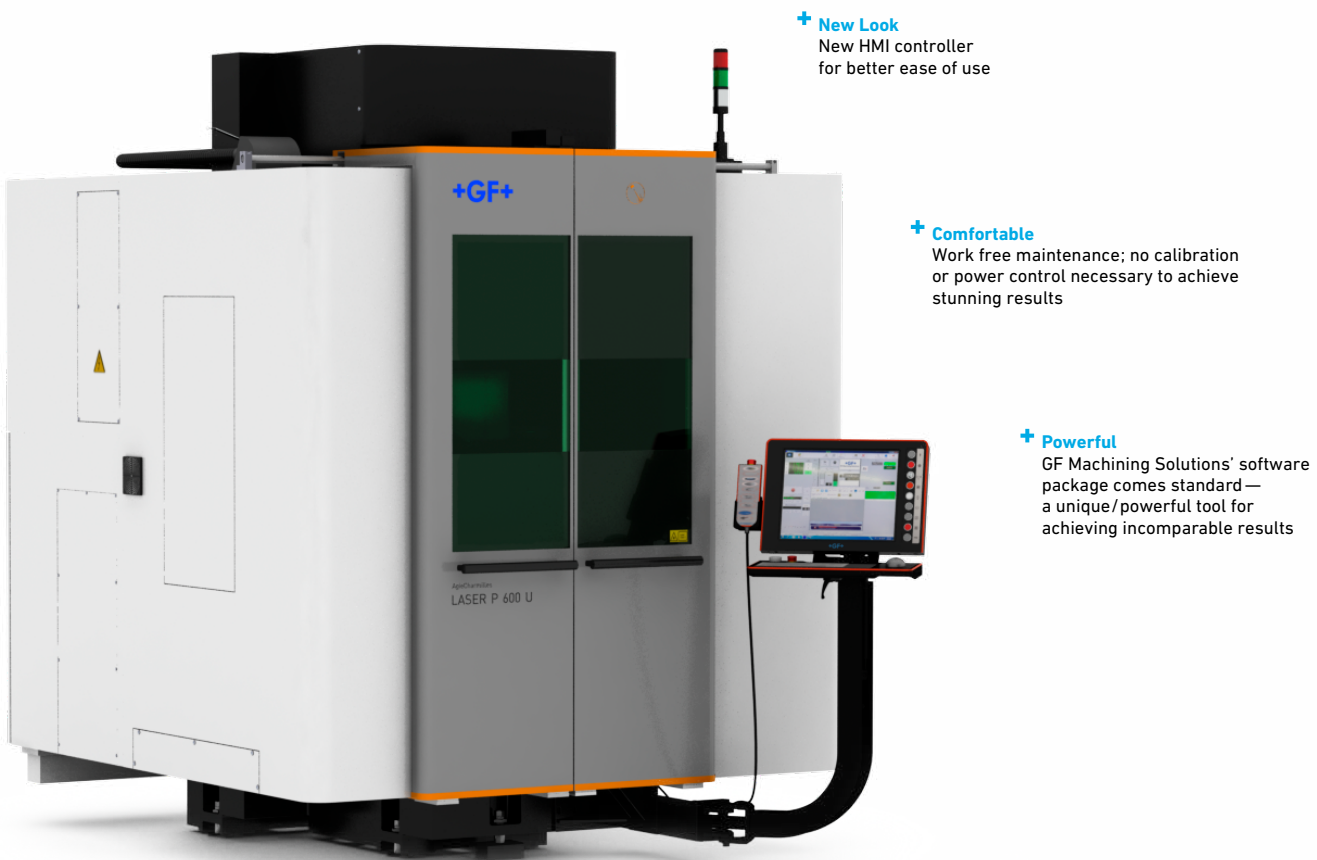

+ **New Look**
New HMI controller
for better ease of use

+ **Comfortable**
Work free maintenance; no calibration
or power control necessary to achieve
stunning results

+ **Powerful**
GF Machining Solutions' software
package comes standard —
a unique/powerful tool for
achieving incomparable results

A wide variety of material

Laser machines easily texture a wide variety of materials. This includes steel, aluminum, carbide, brass, graphite, copper and ceramics. Our unparalleled machine fleet, design, support, automation solutions, and Customer Services, are all things to trigger your experience to excellence.

Total freedom of design

The advantages of using a process 100% digitized combined with our products are undeniably impressive. What you see is what you get, and achieve perfect repeatability, without limits on design or quality.

Versatile texturing solution

Supporting designers' creativity

Using digital technology for design minimizes the risk of deviation from your original idea. You can think and create with no limitations.

Expert support for your creative process

Our Laser texturing process starts with a digital bit-map/grayscale file created in-house or from a natural surface by reverse engineering via 3D scanner. Our software eliminates the guesswork, allowing our Laser products to recreate your distinct designs on large and complex surfaces with expected results.

Enhancing your manufacturing process

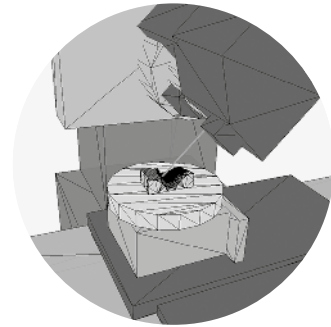

Higher detail and contrast reproduction

Laser texturing combined with a heat and cool molding process opens even more design possibilities. The heat and cool process allows you to achieve high-gloss surfaces, achieve high-quality reproduction of Laser textures, increase contrasts between surfaces, and improve your texture visibility.

Fully digitized process for infinite repeatability

GF Machining Solutions' Laser technology uses a fully digital process for five axis texturing and engraving. Our smart mapping solution manages random and overlapped textures to provide continuity of your design when it is applied to the end product.

Fast, accurate surface calculation

Fast, accurate and easy surface calculation is built into our Laser solutions, saving you time and increasing your productivity.

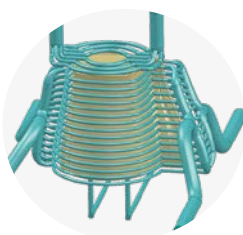
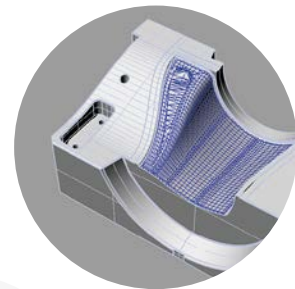

Electronic consumers

Data manufacturing

Listening to your needs, GF Machining Solutions offers multiples possibilities in the ICT world. Up to the finest details, GF Machining Solutions' Laser technology allows you to fulfill the needs of the ICT industry. From mobile phones to laptops and many other applications, our years of experience in these fields makes us the reference for globally renowned brands.

Texture small cavities

Don't let manufacturing methods associated with miniaturization slow your creativity. With Laser texturing, you can texture product areas that standard chemical techniques cannot and even achieve, and also provide the desired accuracy on 3D shapes.



Packaging

Optimize and simplify your process

Productivity, quality, and product differentiation are three key success factors in today's fast-moving global Marketplace. Particularly in the packaging sector, where mold makers and designers are looking for new manufacturing and design possibilities. As a long-time, expert partner to packaging manufacturers worldwide, we are the single-source provider of the solutions you need today.

Optimize lead times with quality

The design of most plastic food containers incorporates contrasts between glossy and/or matte surfaces. With our solution simply and precisely generates a blasting effect, eliminating the need for insert polishing and human intervention.

Control risk of outsourcing

Texturing of PET and glass bottles is usually done with traditional methods involving acid and humans. Laser texturing overcomes these difficulties by introducing a perfectly stable and repeatable process to the manufacturing chain. Experience new product design possibilities while controlling quality over your manufacturing chain.

Simplify processes

Our Laser technology optimizes your time by making your process simpler and our Automation solutions increase your productivity.



Automotive

Innovation in motion

GF Machining Solutions' Laser texturing technology is poised to revolutionize functional surface texturing. Moreover, our Laser technology is a clean, sustainable solution for applications like the distinct aesthetic texturing of molds for automotive tires, lighting modules, interiors and more.

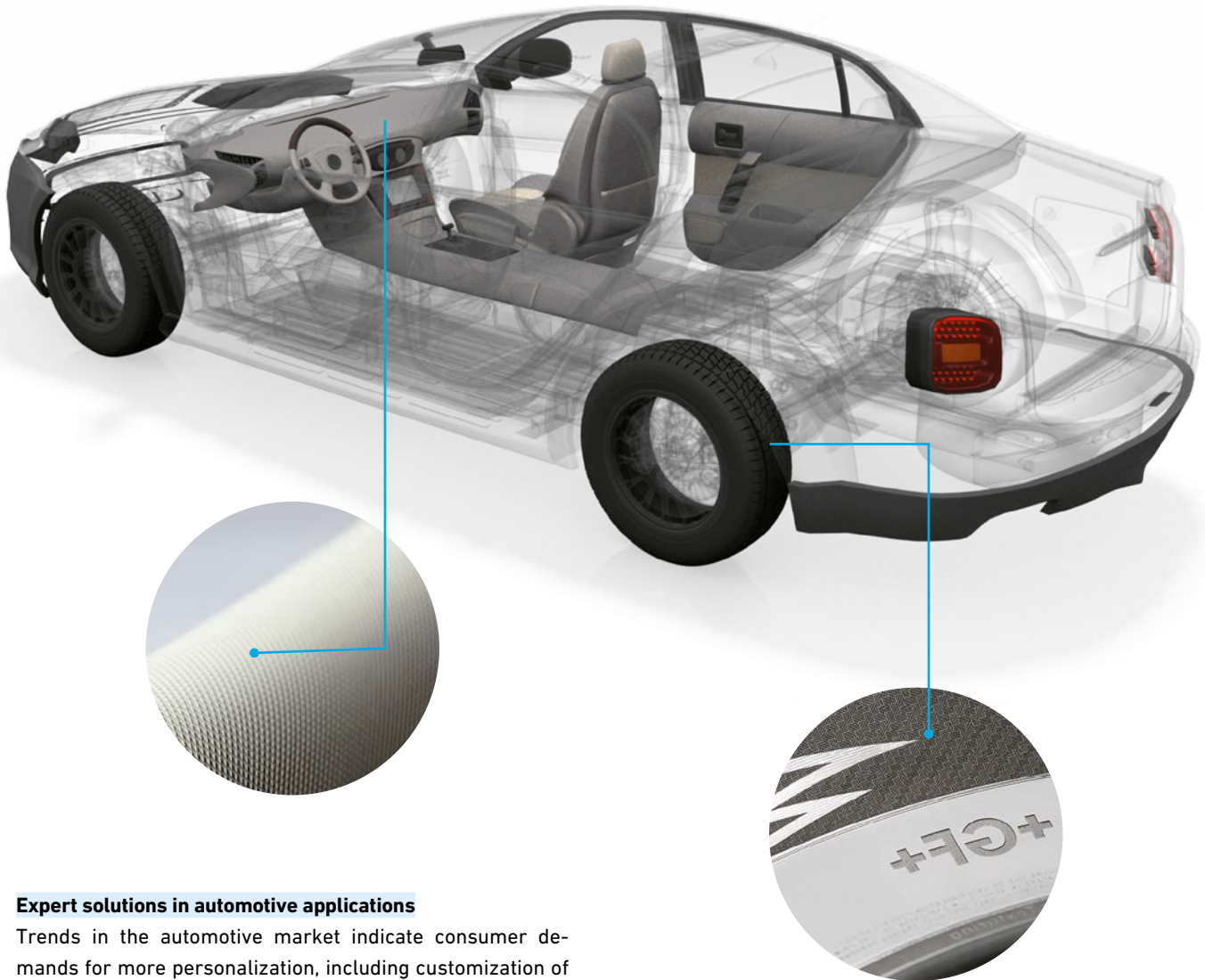

Expert solutions in automotive applications

Trends in the automotive market indicate consumer demands for more personalization, including customization of car exteriors and interiors while geometrical textures in automotive interiors are more and more popular in this sector. Laser texturing machines from GF Machining Solutions help manufacturers to fulfill these demands, guaranteeing quality, repeatability, and continuity between arts. That's the plus of working with the market reference in mold texturing.

Increase your brand's visibility

Logos on molds for tire sidewalls are crucial in the tire industry. By increasing contrasts, Laser texturing raises the visibility of your brand and ramps up the perceived value of your product. Increase your visibility by 50 percent.

Automotive

Control quality with digital technology

Minimize risks by boosting quality and time to market

Previously subcontracted, matte surfaces on car lighting elements are feasible in your own workshop right after milling and polishing while eliminating the risk of human errors compromising your mold quality. Our Laser texturing automatically reproduces a sand blasting effect. Benefit from the advantages of a digital technology: no human errors, 100 percent repeatability of your sand blasting effect, perfect reproduction of your own texture and mark. With GF Machining Solutions, you master your process by doing it all in-house.



Optimize light diffusion

New-generation car lighting has lenses with surface texture to optimize light diffusion. Laser technology helps you guarantee homogenous light coverage to improve quality and guarantee safe driving.

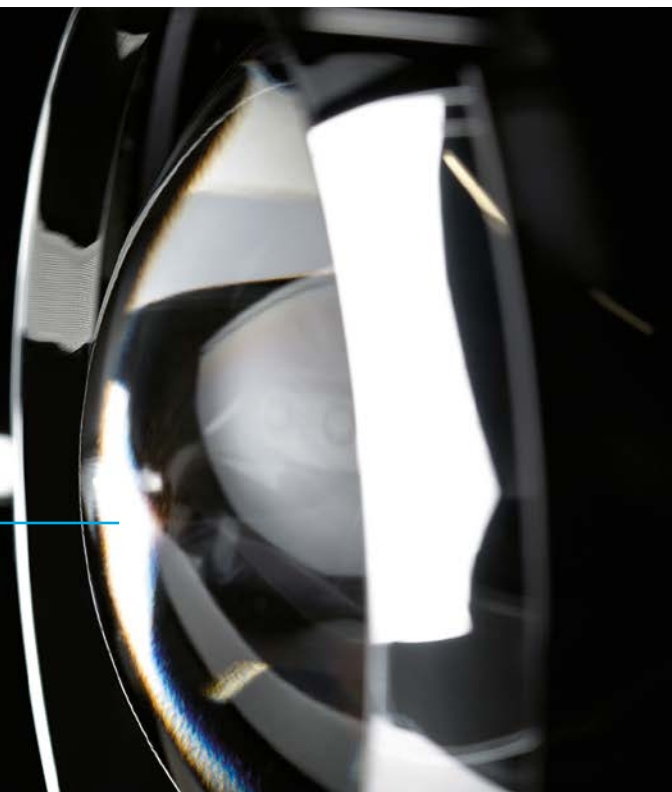
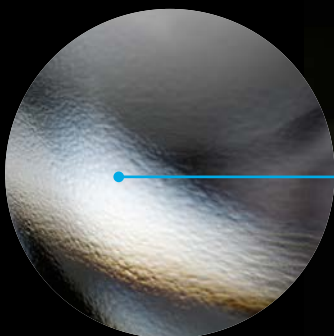

Ease of use

Designed for users

GF Machining Solutions optimizes your ease of use. Whatever your application needs, we have a solution to drive your success.



You choose the lens you need

Our Laser solution allows you to select the specific lens needed to realize your particular application (with f-Theta from 100 up to 420 mm).



Accurate and fast positioning measurement

All in one, our unique Laser head guarantees high positioning accuracy and fast, accurate tool measurement. Work accurately with one Laser head set as standard.



A wide range of laser source

Starting from 20 W for high demand quality applications to 30 W, 50 W or 100 W for efficient laser machining, we know exactly the solution matching your application for the best costs performances ratio.

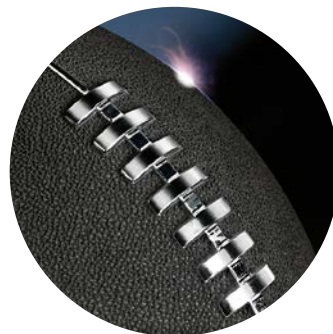

The most powerful software package

Developed by GF Machining Solutions, the all-in-one dedicated software package allows you to master your job from the preparation phase and, graphic design all the way through to, transition-free patching and, UV mapping for applying texture and 3D simulation. Our all-in-one package delivers machining results aligned with your expectations.

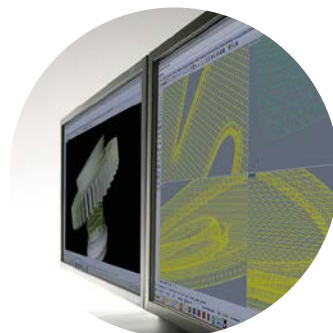



Higher degree of autonomy

Increase your productivity

Experience always shows that measures to reduce the idle times of your machines are significantly more worthwhile than chasing seconds in the actual machining process. The solution is a stable and exact reference system. This lets you preset away from the machine and then set up the machine with minimum idle time, quickly and precisely with System 3R tooling, part of GF Machining Solutions.

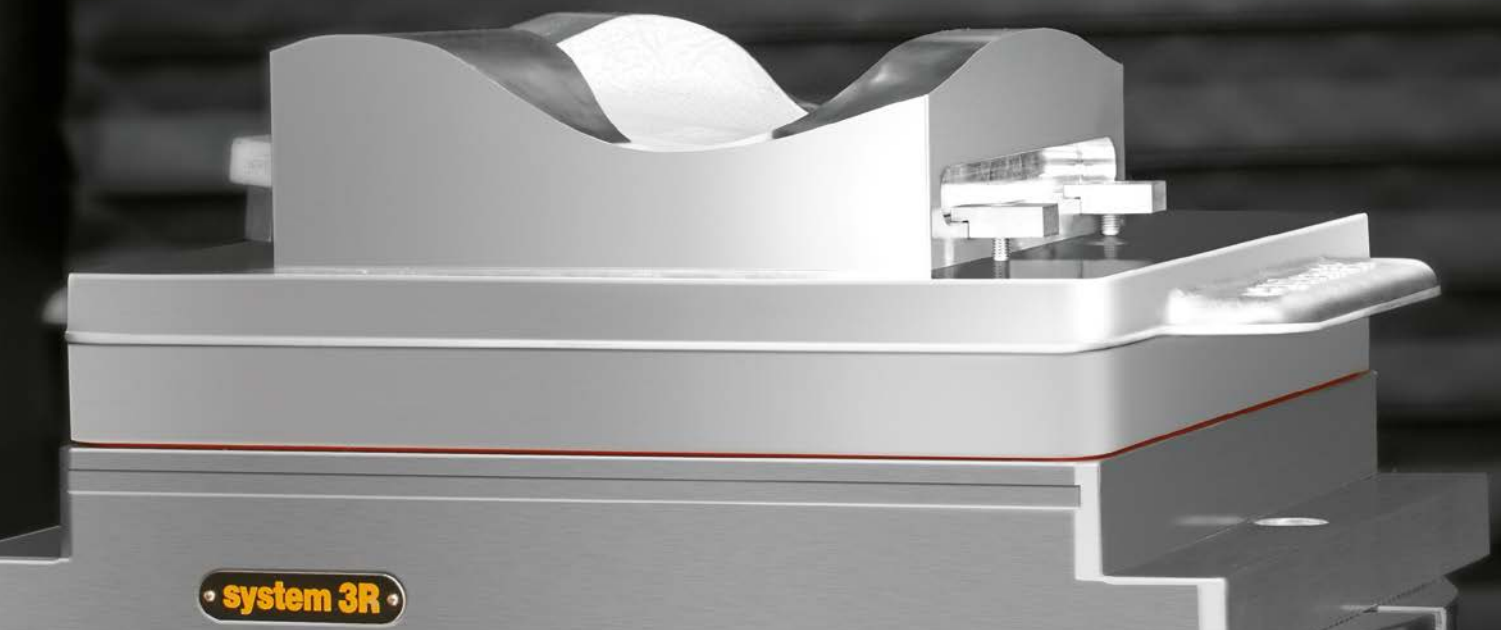

One partner to optimize your productivity

We deliver a large range of tooling to match your application and reduce unproductive times on your machine.

Tooling		LASER P 600 U	LASER P 1000 U	LASER P 1200 U	LASER P 4000 U
Macro	54/70/Ø75/Ø116	X			
GPS 120	Ø120	X			
MacroMagnum	Ø156	X	X		
GPS 240	240/300	X	X	X	
Dynafix	280/350		X	X	
Delphin	410 – 500			X	
Delphin	510 – 700			X	
Specific				X	X

Higher degree of autonomy

Add flexibility

Flexibility, including solutions that can accommodate production changes to match your business and environment, is a key success factor in today's marketplace. To make your machines more flexible in handling workpieces of various sizes, various chuck adapters are available for all of our tooling systems.

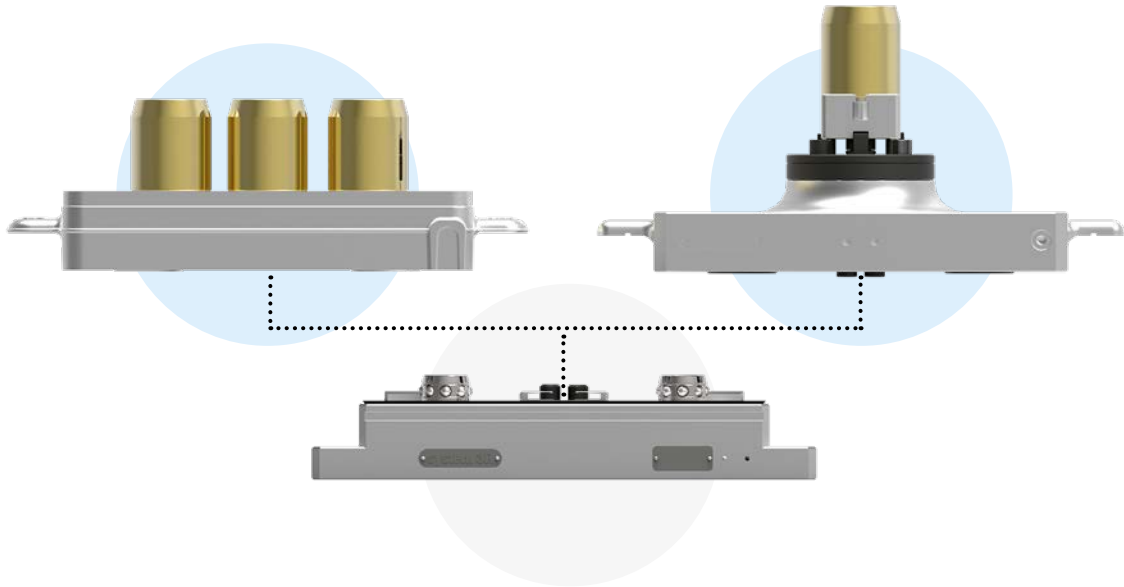

Boost your competitiveness

Automation keeps production going whatever the time of day or day of the week. You achieve shorter lead times, higher productivity and quicker payback of capital invested in machines. With automated operations, production can continue running around the clock, seven days a week. Possibilities are endless.



Act responsibly

Produce with more respect and less impact

Environmental sustainability is a major issue today and beyond, and GF Machining Solutions is committed to reducing impacts on the environment. Our Laser texturing technology plays a major role in producing textured products in a cleaner, more efficient way.

Reduced impact compared to traditional texturing methods

Laser texturing reduces the need for traditional methods that pollute the environment and limit your design potential. Our clean, non-polluting Laser technology allows you to texture in-house and, as a digital process, it is perfectly aligned with Industry 4.0.

Save energy

Requiring no oil or consumables, our Laser texturing solution is one of the market's lowest energy consumers, allowing you to save money and contribute to environmental sustainability.

Technical specifications



LASER P 600 U



LASER P 4000 U

		LASER P 600 U	LASER P 1000 U	LASER P 1200 U	LASER P 4000 U
Machine					
Nano Flexipulse Laser	W	50/100	50/100	100	100
Focal length	mm	100/160/254	100/160/254	100/160/254	330/420
	in	3.9/6.3/10	3.9/6.3/10	3.9/6.3/10	6.3/10/12.3/16.5
Machine dimensions *	mm	2050 x 2280 x 2770	2240 x 2678 x 2770	2240 x 3404 x 2932	7000 x 10000 x 5250
	in	80.7 x 89.8 x 109	88.2 x 105.43 x 109	88.2 x 134 x 115.43	275.6 x 393.7 x 206.7
Approx machine weight	kg	5000	6500	8700	32000
	lbs	11023	14330	19180	70548
Max. power consumption	kW	4	4	4	12.5
Axes					
X,Y, Z travels	mm	600 x 460 x 830	1000 x 550 x 880	1200 x 900 x 1200	4000 x 3000 x 1500
	in	23.6 x 18.1 x 32.7	39.4 x 21.6 x 34.6	47.2 x 35.4 x 47.2	157.5 x 118.1 x 59
Laser titling axis A	°/s, °	180, 210	180, 210	180, 210	180, 270
B axis max. speed	°/s, °	180	160	90	180, 370
B axis table diameter	mm	180	380	800	-
	in	7.08	15	31.5	-
Work area					
Max 5 axis machining volume	mm	Ø 370 x 530 **	Ø 460 x 570	Ø 590 x 770	2800 x 1800 x 1170
	in	Ø 14.6 x 20.9 **	Ø 18.1 x 22.44	Ø 23.23 x 30.31	110.2 x 70.9 x 46.1
Max workpiece volume	mm	Ø 420 x 530	Ø 510 x 480	Ø 920 x 790	4000 x 3000 x 1170
	in	Ø 16.5 x 20.9	Ø 20.1 x 18.9	Ø 36.2 x 31.1	157.5 x 118.1 x 46.1
Max workpiece weight 5 axis	kg	75	150	< 1200	20000
	lbs	165	330	< 2645	44092

* Width x depth x height ** FL160

About GF Machining Solutions

Multi-technology solutions provider

Our commitment to you and your specific applications is proven by the value-adding intelligence, productivity and quality delivered by our multi-technology solutions. Your success is our chief motivator. That's why we are continuously advancing our legendary technical expertise. Wherever you are, whatever your market segment and whatever the size of your operation, we have the complete solutions and the customer-centric commitment to accelerate your success—today.

EDM (Electrical Discharge Machining)



Wire-cutting EDM

GF Machining Solutions' wire-cutting EDM is fast, precise and increasingly energy efficient. From ultraprecise machining of miniaturized components down to 0.02 mm to powerful solutions for demanding high-speed machining with respect to surface accuracy, our wire EDM solutions position you for success.

Die-sinking EDM

GF Machining Solutions is revolutionizing die-sinking EDM with features like iGAP technology to dramatically boost machining speed and reduce electrode wear. All of our die-sinking systems offer fast removal and deliver mirror finishes of Ra 0.1 µm (4 µin).

Hole-drilling EDM

GF Machining Solutions' robust hole-drilling EDM solutions enable you to drill holes in electrically conductive materials at a very high speed—and, with a five-axis configuration, at any angle on a workpiece with an inclined surface.

Tooling and Automation



Tooling

Our customers experience complete autonomy while maintaining extreme accuracy, thanks to our highly accurate System 3R reference systems for holding and positioning electrodes and work pieces. All types of machines can easily be linked, which reduces set-up times and enables a seamless transfer of workpieces between different operations.

Automation

Together with System 3R, we also provide scalable and cost-effective Automation solutions for simple, single machine cells or complex, multi-process cells, tailored to your needs.

Milling



Milling

Precision tool and mold manufacturers enjoy a competitive edge with our Mikron MILL S solutions' fast and precise machining. The Mikron MILL P machines achieve above-average productivity thanks to their high performance and Automation. Customers seeking fastest return on investment benefit from the affordable efficiency of our MILL E solutions.

High Performance Airfoil Machining

Our Liechti turnkey solutions enable the highly dynamic manufacturing of precision airfoils. Thanks to the unique performance and our expertise in airfoil machining, you increase productivity by producing at the lowest cost per part.

Spindles

As part of GF Machining Solutions, Step-Tec is engaged in the very first stage of each machining center development project. Compact design combined with excellent thermal and geometric repeatability ensure the perfect integration of this core component into the machine tool.

Software



Digitalization solutions

To drive its digital transformation, GF Machining Solutions acquired symmedia GmbH, a company specialized in software for machine connectivity. Together, we offer a complete range of Industry 4.0 solutions across all industries. The future requires the ability to adapt quickly to continual digital processes. Our intelligent manufacturing offers embedded expertise, optimized production processes, and workshop Automation: solutions for smart and connected machines.

Advanced manufacturing



Laser texturing

Aesthetic and functional texturing is easy and infinitely repeatable with our digitized Laser technology. Even complex 3D geometries, including precision parts, are textured, engraved, microstructured, marked and labeled.

Laser micromachining

GF Machining Solutions offers the industry's most complete line of Laser micromachining platforms optimized for small, high-precision features to meet the increasing need for smaller, smarter parts to support today's leading-edge products.

Laser Additive Manufacturing (AM)

GF Machining Solutions and 3D Systems, a leading global provider of additive manufacturing solutions and the pioneer of 3D printing, have partnered to introduce new metal 3D printing solutions that enable manufacturers to produce complex metal parts more efficiently.

Service + Success



We take you to new heights

Our Success Packs are designed to maximise your return on investment and empower you in your quest for success across all industrial segments. Our subscription packs feature a comprehensive range of services that guarantee the access and support you need to get the most out of your assets today, while preparing for the challenges of tomorrow. Our trusted experts backed by our latest cutting-edge, intelligent Digital Solutions, provide a full range of services.

eCatalog

Keep your equipment operating at peak precision and performance with our wide range of certified consumables and original wear parts. Our online catalog has it all (ecatalog.gfms.com).



Our locations

Switzerland

Headquarters
Biel/Bienne +++

Losone +++
Geneva ++
Langnau ++

Europe

Schorndorf, Germany ++
Coventry, United Kingdom ++
Agrate Brianza (MI), Italy ++
Barcelona, Spain ++
Marinha Grande, Portugal +
Massy, France +
La Roche Blanche, France +
Lomm, Netherlands ++
Altenmarkt, Austria ++
Warsaw, Poland ++
Brno, Czech Republic ++
Budapest, Hungary ++
Vällingby, Sweden +

America

USA
Lincolnshire (IL) ++
Chicago (IL) ++
Huntersville (NC) ++
Irvine (CA) ++

Toronto (Vaughan), Canada ++
Monterrey, Mexico ++
São Paulo, Brazil +
Caxias do Sul, Brazil +

Asia

China
Beijing +++
Changzhou ++
Shanghai ++
Chengdu ++
Dongguan ++
Hong Kong +

Yokohama, Japan ++
Taipei, Taiwan +
Taichung, Taiwan ++
Seoul, Korea ++
Singapore, Singapore ++
Petaling Jaya, Malaysia ++
Bangalore, India ++
Pune, India +
Hanoi, Vietnam ++

+ Plant ++ Center of Demonstration +++ Sales company

At a glance

We enable our customers to run their businesses efficiently and effectively by offering innovative Milling, EDM, Laser, Additive Manufacturing, Spindle, Tooling and Automation solutions. A comprehensive package of services completes our proposition.

www.gfms.com



© GF Machining Solutions Management SA, 2024
The technical data and illustrations are not binding.
They are not warranted characteristics and are
subject to change.